

NE59J3420SS

5.9 cu. ft. Freestanding Electric Range

Features

- Convection Oven
- Large Oven Capacity – 5.9 cu. ft.
- SteamQuick™ (20 min. oven cleaning) and Self Clean
- Five Electric Cooktop Elements
 - One Dual Burner (9"/12")
 - One Dual Burner (6"/9")
 - Two Single Burners (6")
 - Warming Center (7")

Convenience

- Hot Surface Indicator Light
- Auto Oven Light
- Proofing
- Sabbath Mode
- Kitchen Timer
- Delay Start
- Child Safety Lock
- 4 Easy Cook Presets



Convection Oven



Large Capacity

Available Colors



Stainless Steel
(shown)



Black

Signature Features

CONVECTION OVEN

- The convection fan oven system is great for baking and broiling because heat is distributed thoroughly and food cooks evenly. Enjoy faster results each time.

LARGE CAPACITY

- Our extra-spacious 5.9 cu. ft. large-capacity oven easily handles turkey roasters and large baking sheets.

STEAMQUICK™

- Choose Steam for a quick 20-minute clean or choose Self Clean for a deeper clean.

ADJUSTABLE COOKTOP ELEMENTS

- Easy-to-maintain ceramic cooktop with the flexibility of five elements including two dual burners.



Ranked **"Highest in Customer Satisfaction with Ranges, Cooktops and Ovens."***

—J.D. Power

SAMSUNG

NE59J3420SS

5.9 cu. ft. Freestanding Electric Range

Installing Your Range

*30" minimum clearance between the top of the cooking surface and the bottom of an unprotected wood or metal cabinet; or 24" minimum when the bottom of the wood or metal cabinet is protected by not less than 1/4" flame-retardant millboard covered with not less than no. 28 MSG sheet steel, 0.015" stainless steel, 0.024" aluminum or 0.020" copper.

**15" minimum between the countertop and the adjacent cabinet bottom.

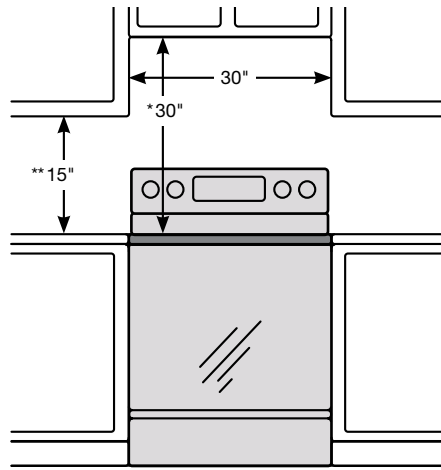

IMPORTANT: To eliminate the risk of burns or fire caused by reaching over heated surface units, cabinet storage space located above the surface units should be avoided. If cabinet storage is to be provided, the risk can be reduced by installing a range hood that projects horizontally a minimum of 5" beyond the bottom of the cabinets.

Dimensions

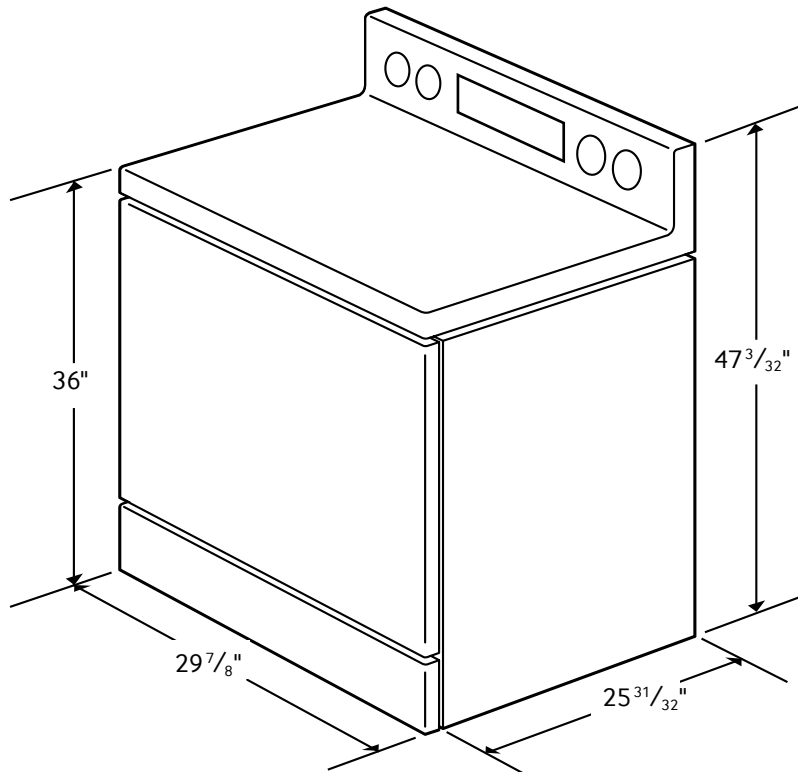

Radiant Ceramic Cooktop

- Right Front: 9/12", 3.0 kW
- Left Front: Radiant 6/9", 3.0 kW
- Right Rear: Radiant 6", 1.2 kW
- Left Rear: Radiant 6", 1.2 kW
- Center Rear: Warming Center, 7"

Oven

- Hidden Bake Element
- Bake: 175°F–550°F
- Convection Bake: 175°F–550°F
- Convection Roast: 175°F–550°F
- Convection Element/Heater: 800 W
- Broil: Low/High
- Proofing
- Sabbath Mode

Storage Drawer

Capacity: 1.4 cu. ft.

Warranty

One (1) Year All Parts and Labor
Five (5) Years Electric Cooktop

Product Dimensions & Weight (WxHxD)

Actual Oven Dimensions:
25" x 20²⁵/₃₂" x 18¹⁵/₁₆"

Outside Net Dimensions:
29⁷/₈" x 47³/₃₂" x 25³¹/₃₂"

Weight: 159.2 lbs. (157.0 Black Model)

Shipping Dimensions & Weight (WxHxD)

Dimensions:
33¹/₃₂" x 50²⁵/₆₄" x 30⁹/₃₂"

Weight: 194.5 lbs. (194.5 Black Model)

Color	Model #	UPC Code
Stainless Steel	NE59J3420SS	887276107240
Black	NE59J3420SB	887276107233

SAMSUNG

Samsung received the highest numerical score for ranges, cooktops and ovens in the proprietary J.D. Power 2014 Kitchen Appliance StudySM. Study based on 15,380 total responses measuring 17 ranges, cooktops and oven brands and measures opinions of consumers about their new appliance purchased in the past 24 months. Proprietary study results are based on experiences and perceptions of consumers surveyed in January-March 2014. Your experiences may vary. Visit jdpower.com.

Actual color may vary. Design, specifications, and color availability are subject to change without notice. Non-metric weights and measurements are approximate.

©2015 Samsung Electronics America, Inc. 85 Challenger Road, Ridgefield Park, NJ 07660. Tel: 800-SAMSUNG. samsung.com. Samsung is a registered trademark of Samsung Electronics Co. Ltd.